

Quick Start Guide | XpressChef™ 3i High Speed Commercial Oven

Refer to Product Safety Manual for Safety Statements. Complete Owner's Manual available online

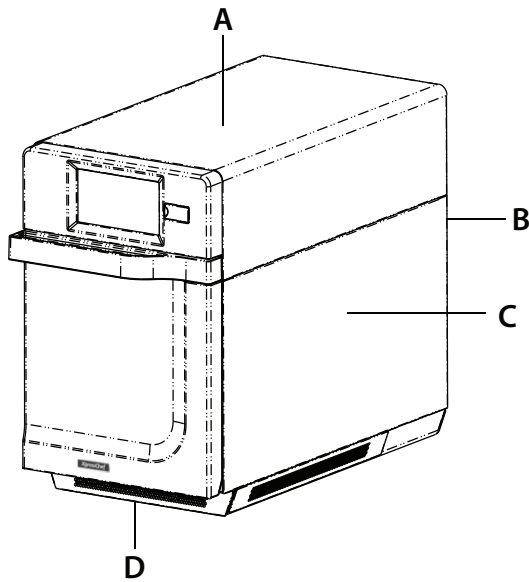

Oven Clearances

- A. Allow at least 2" (5.1 cm) of clearance around top of oven. Proper air flow around oven cools electrical components. With restricted air flow, oven may not operate properly and life of electrical parts is reduced.
- B. There is not an installation clearance requirement for the back of the oven.
- C. Allow at least 1/2" (1.27 cm) of clearance around sides of oven.
- D. Install oven so oven bottom is at least 3 feet (91.5 cm) above floor.

Oven Operation

Turn the Oven On, Preheat



This oven can be set to a preheat temperature between 200°F (95°C) and 520°F (270°C).

1. Oven must be plugged in.
(Screen will power on to "Standby mode" within approximately 30 seconds.)
2. Touch the green power icon
3. The preheat temperature of the oven will appear in the display.



Touch the power key again to interrupt preheating, or touch the blue menu icon to access main menu and user options.

Care and Cleaning Basics

Refer to Owner's Manual for complete instructions and recommendations (available online)

DO wear protective gloves and glasses

DO always use recommended cleaning supplies: Damp towel, plastic scouring pad, ACP Oven Cleaner (CL10) and ACP Oven Shield Protectant (SH10).

DO allow oven and tools to cool before cleaning

DO NOT use caustic cleaning products

DO NOT use water pressure style cleaning systems

DO NOT spray cleaning solution into perforations.

Cooking with Preprogrammed Menu Items

1. After oven has preheated to desired temperature, open oven door, place food in oven and close door
2. Scroll to choose desired food item from menu and touch the food item you wish to cook. The cook cycle will begin and screen will show remaining cook time.

Note: If "Preheat Warning" is enabled (customized user setting) and preheat temperature differs from default preheat temperature, the control will interrupt cook cycle.

3. At the end of the cooking cycle, the oven beeps, and displays animation. Use oven mitts and/or paddle to carefully remove food from oven.

Quick Start Guide | XpressChef™ 3i High Speed Commercial Oven

Manual Cooking

Note: “Manual cooking” must be enabled in user options (see page 6)

Use manual cooking when a specific entered time and cooking power levels are desired. It's very useful when you are experimenting with new food items. Maximum cook time is 99:99 (100 minutes and 13 seconds). Microwave and Fan can be set to power levels between 0-100%.

Note: You may also create and edit recipes using the ACP Programming Application.



1. After oven has preheated touch blue menu icon.

Note: To guarantee that oven reaches the desired temperature before the start of cook cycle, enable “Preheat Warning” in user options

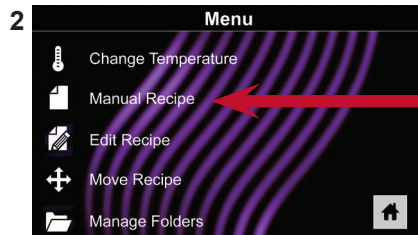

2

2. Touch the “Manual Recipe” option.



3. To change **cooking temperature** for recipe, touch temperature icon on the left, and input new temperature. Two frequently used temperatures will appear for quick selection. Touch green check mark after inputting a temperature.



4. For Stage 1, enter **cooking time** by touching time entry box. A number pad will appear. Enter the desired cook time. Touch the “OK” icon.



5. Select desired **microwave power** by touching microwave power/Fan entry box. Choose from options ranging from 0% - 100%.



6. Select desired **fan speed** by touching fan speed entry box. Choose from options ranging from 0% - 100%.

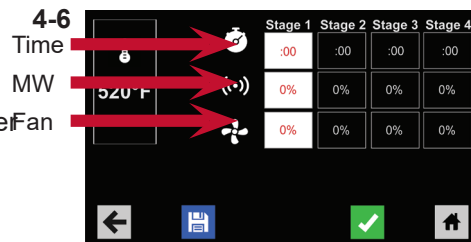

7. Repeat steps 4-6 for each cooking stage, if more than one cooking stage is necessary.

Note: To save without cooking first, touch the save icon.  Follow instructions on the next page.



8. Open oven door and place food in oven. Touch green check mark icon to begin cooking.

Once the cook cycle is complete, open door and use oven mitts and/or paddle to carefully remove food.

The display will return to the manual input screen. See instructions on next page to save and edit menu item from manual cook.

Quick Start Guide | XpressChef™ 3i High Speed Commercial Oven

Save a Menu Item from Manual Cook:



1. To save the settings and create menu item, touch the blue save icon



2. Choose a background color and icon, or an image to customize the menu item. Touch the right arrow to move to the next screen.



3. Name recipe and touch the green check mark to save.

4. To reorganize menu items, you may touch, hold and drag them. Touch green check mark to complete this step and save the menu item.

Note: For larger, and more complex menus, it may be more manageable to create and edit menus using the ACP Programming Application. For detailed instructions, please visit: acpsolutions.com/oven-programming/



Manually Edit an Existing Menu Item:



1. Touch the blue menu icon at the bottom of the screen.

2. Touch the “Edit Recipe” option.

3. Touch the desired recipe to be edited. The control will prompt you to the manual editing screen, where you may revise the cooking settings.



To delete the menu item, touch the orange garbage can icon. Touch the green check mark to confirm, or touch the “X” to dismiss.

4. **Note:** Skip this step if you do not want to cook anything.

Open the oven door and place the food in the oven. Touch green check mark icon to begin cooking with the revised menu item settings. The display will return to the manual input screen at the end of the cook cycle.



5. Touch the right arrow icon to save any changes made to cook settings and move to the next screen.



6. If desired, choose a different background color. Touch the right arrow to select an image at the next screen. Touch the right arrow again to move to the next screen.



7. If desired, change the name of the recipe. Touch green check mark to save the menu item.



Manually Move Recipe:



1. Touch the blue menu icon at the bottom of the screen.

2. Touch the “Move Recipe” option.

3. Touch, hold, and drag recipes to different locations on the screen

Move a recipe into a folder: Touch, hold and drag the recipe to the folder.

Move a recipe out of a folder: Touch, hold and drag the recipe to the top of the screen



Quick Start Guide | XpressChef™ 3i High Speed Commercial Oven

Caution: Uploading a new file will overwrite existing items on oven. To ensure items are not lost, first backup files by exporting to USB drive.

Export Menu via USB Flash Drive



1. Touch the blue menu icon at the bottom of the screen.
2. Scroll down and touch the “Load File” option
3. When prompted, insert the flash drive into the USB port
4. When prompted, select “Export Files”.
“Copying Files” screen will appear.
Do **not** remove USB Flash Drive until “Success” screen appears.
5. Once the file have copied, touch the “Home” icon to return to the main screen. Remove USB Flash Drive.
Settings and menu items will be loaded on USB Flash Drive and ready to share or open in ACP Programming Application .



Open Menu in ACP Programming Application

Note: For more comprehensive instructions, see ACP Programming Application User Guide online

1. Insert flash drive into USB port on computer.
2. Open ACP Programming Application.
3. Select “File,” then “Open.” Navigate to flash drive.
Select the menu file and open.

Import Menu via USB Flash Drive



1. Touch the blue menu icon at the bottom of the screen.
2. Scroll down and touch the “Load File” option
Caution: Uploading a new file will overwrite existing items on oven. To ensure items are not lost, first backup files by exporting to USB drive.

3. When prompted, insert the flash drive into the USB port
4. Touch the desired file to be uploaded.

5. Once file has uploaded, touch the “Home” icon to return to the main screen.
Settings and menu items will now be loaded and ready to use.

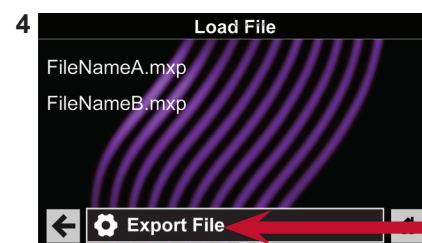
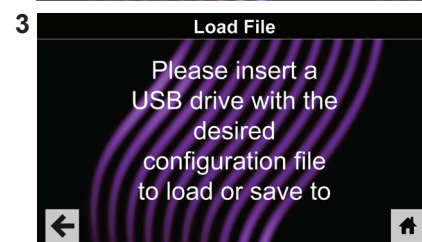
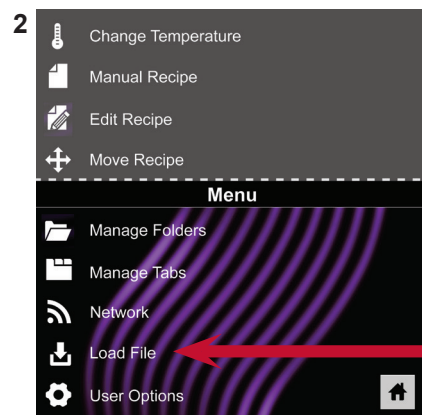

Quick Start Guide | XpressChef™ 3i High Speed Commercial Oven

Connect Oven to Network:



1. Touch the blue menu icon at the bottom of the screen.
2. Touch the “Network” option.
3. Connect to network using your choice of Ethernet or Wifi:

To connect via Wi-Fi:

- Enable Wi-Fi capability by touching the “On” option.
- Select the desired Wi-Fi network. Enter the network’s password. If the network does not immediately appear, touch “Search” to locate the Wi-Fi network.

To connect via Ethernet:

- Make sure the Ethernet cord is plugged into the back of the oven and wall jack. If necessary, use pliers to gently remove plastic plug from Ethernet port on right rear of oven. Insert Ethernet cable.

2

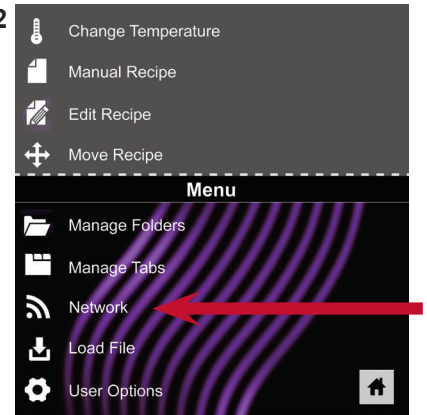

Connect Computer to Oven via Wi-Fi/Ethernet:

1. Connect computer to same network and enter password.
2. An IP address will appear on oven control once it has connected to the network. Open an internet browser window on computer and type in the IP address exactly as it appears on oven screen.
3. Enter your log-in information:

Log-in Information	
Username	ACP_MXP
Password	Express

4. The oven and computer are now connected.

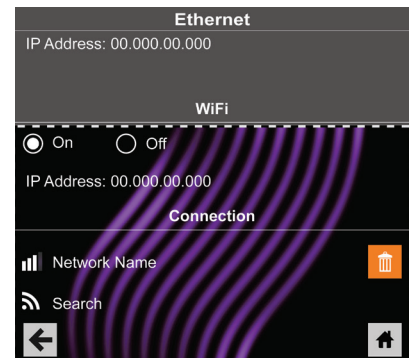

Transfer Recipe Information via Wi-Fi/Ethernet:

1. After connecting the computer to the oven and logging in, click on the “Upload Recipes” tab in browser window.

Caution: *Uploading a new file will overwrite existing items on oven. To ensure items are not lost, first backup files by exporting to USB drive.*



2. Upload menu file by following the instructions on web page. Touch the green check mark.
3. Once the file has been fully uploaded, a message will appear that says “Upload Successful!” The recipes will be imported when the oven enters standby mode.”



4. To cycle the oven through standby mode, touch the home icon then the green power icon. Oven will begin cooling down. Touch the red stop icon to return to home screen. Menu items and settings will be uploaded and ready to use.

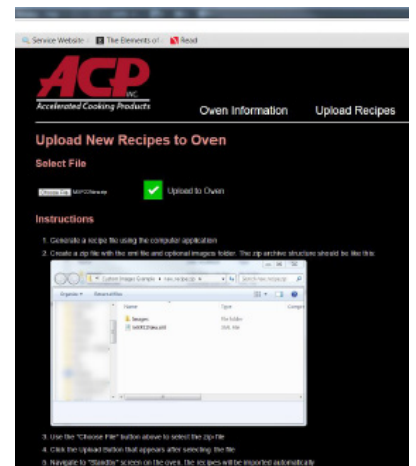

Quick Start Guide | XpressChef™ 3i High Speed Commercial Oven

There are several options you can change to customize the operation of the oven for your business. The table below shows these options; the **factory setting is shown in bold type**.

2

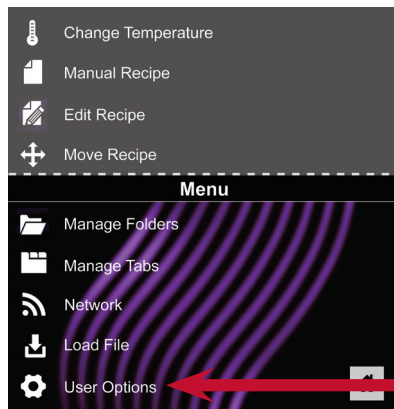

Access and Modify User Options:



1. Touch the blue menu icon at the bottom of the screen.

2. Scroll down and touch to select “User Options.”



3. Use this menu to modify oven settings.

Touch the left arrow to return to the menu after making each change.

Note: You may also make user options changes using the ACP Programming Application.

User Option	STANDARD DEFAULT PER MODEL	
	XpressChef™ 3i, 60Hz	XpressChef™ 3i, 50Hz
Language	English , Chinese (Mandarin), Japanese, Korean, Russian, German, French, Italian, Polish, Danish, Greek, Latin, Swedish, Portuguese, Spanish, Thai, Lao, Dutch, Vietnamese, Arabic, Ukrainian, Filipino, Norwegian, Hindi, Bengali	English , Chinese (Mandarin), Japanese, Korean, Russian, German, French, Italian, Polish, Danish, Greek, Latin, Swedish, Portuguese, Spanish, Thai, Lao, Dutch, Vietnamese, Arabic, Ukrainian, Filipino, Norwegian, Hindi, Bengali
Time	12 Hr 24 Hr	12 Hr 24 Hr
Date	MM / DD / YYYY DD / MM / YYYY	MM / DD / YYYY DD / MM / YYYY
Temperature Scale	Celsius Fahrenheit	Celsius Fahrenheit
Preheat Temperature <i>200°F - 520°F (93°C - 270°C)</i>	520°F (270°C)	270°C (520°F)
Keypad Activation	30 seconds 60 seconds 2 minutes	30 seconds 60 seconds 2 minutes
Brightness	Low Med High	Low Med High
Key Beep	On Off	On Off
Volume	Low Medium High	Low Medium High
End of Cycle Beep	Three Beeps (Once) Three Beeps (Repeating) Continuous Until Door is Opened	Three Beeps (Once) Three Beeps (Repeating) Continuous Until Door is Opened
Allow Manual Cook	On Off	On Off
Allow Manual Save	On Off	On Off
PIN Code <i>*must be a 4-digit numeric PIN</i>	On* Off	On* Off
Opening Door Behavior	Reset Timer Pauses Cook Cycle	Reset Timer Pauses Cook Cycle
Clean Filter Reminder	Every 7 Days Every 30 Days Every 90 Days Off	Every 7 Days Every 30 Days Every 90 Days Off
Preheat Warning	On Off	On Off
Auto Shut Off	2 Hours 4 Hours 8 Hours Off	2 Hours 4 Hours 8 Hours Off